



POWERING INNOVATION THAT DRIVES HUMAN ADVANCEMENT

© 2025 ANSYS, Inc. or its affiliated companies
Unauthorized use, distribution, or duplication is prohibited.

Getting Started with HFSS™: Optimizing a Waveguide T Junction and Using SpaceClaim Link



ANSYS, Inc.
Southpointe
2600 Ansys Drive
Canonsburg, PA 15317
ansysinfo@ansys.com
<https://www.ansys.com>
(T) 724-746-3304
(F) 724-514-9494

Release 2025 R1
January 2025

ANSYS, Inc. and ANSYS
Europe, Ltd. are UL registered
ISO 9001:2015 companies.

Copyright and Trademark Information

© 1986-2025 ANSYS, Inc. Unauthorized use, distribution or duplication is prohibited.

ANSYS, Ansys Workbench, AUTODYN, CFX, FLUENT and any and all ANSYS, Inc. brand, product, service and feature names, logos and slogans are registered trademarks or trademarks of ANSYS, Inc. or its subsidiaries located in the United States or other countries. ICM CFD is a trademark used by ANSYS, Inc. under license. All other brand, product, service and feature names or trademarks are the property of their respective owners. FLEXIm and FLEXnet are trademarks of Flexera Software LLC.

Disclaimer Notice

THIS ANSYS SOFTWARE PRODUCT AND PROGRAM DOCUMENTATION INCLUDE TRADE SECRETS AND ARE CONFIDENTIAL AND PROPRIETARY PRODUCTS OF ANSYS, INC., ITS SUBSIDIARIES, OR LICENSORS. The software products and documentation are furnished by ANSYS, Inc., its subsidiaries, or affiliates under a software license agreement that contains provisions concerning non-disclosure, copying, length and nature of use, compliance with exporting laws, warranties, disclaimers, limitations of liability, and remedies, and other provisions. The software products and documentation may be used, disclosed, transferred, or copied only in accordance with the terms and conditions of that software license agreement.

ANSYS, Inc. and ANSYS Europe, Ltd. are UL registered ISO 9001: 2015 companies.

U.S. Government Rights

For U.S. Government users, except as specifically granted by the ANSYS, Inc. software license agreement, the use, duplication, or disclosure by the United States Government is subject to restrictions stated in the ANSYS, Inc. software license agreement and FAR 12.212 (for non-DOD licenses).

Third-Party Software

See the legal information in the product help files for the complete Legal Notice for Ansys proprietary software and third-party software. If you are unable to access the Legal Notice, please contact ANSYS, Inc.

Conventions Used in this Guide

Please take a moment to review how instructions and other useful information are presented in this documentation.

- Procedures are presented as numbered lists. A single bullet indicates that the procedure has only one step.
- Bold type is used for the following:
 - Keyboard entries that should be typed in their entirety exactly as shown. For example, “**copy file1**” means you must type the word **copy**, then type a space, and then type **file1**.
 - On-screen prompts and messages, names of options and text boxes, and menu commands. Menu commands are often separated by greater than signs (>). For example, “click **HFSS > Excitations > Assign > Wave Port.**”
 - Labeled keys on the computer keyboard. For example, “Press **Enter**” means to press the key labeled **Enter**.
- Italic type is used for the following:
 - Emphasis.
 - The titles of publications.
 - Keyboard entries when a name or a variable must be typed in place of the words in italics. For example, “**copy filename**” means you must type the word **copy**, then type a space, and then type the name of the file.
- The plus sign (+) is used between keyboard keys to indicate that you should press the keys at the same time. For example, “Press Shift+F1” means to press the **Shift** key and, while holding it down, press the **F1** key also. You should always depress the modifier key or keys first (for example, Shift, Ctrl, Alt, or Ctrl+Shift), continue to hold it/them down, and then press the last key in the instruction.

Accessing Commands: *Ribbons*, *menu bars*, and *shortcut menus* are three methods that can be used to see what commands are available in the application.

- The *Ribbon* occupies the rectangular area at the top of the application window and contains multiple tabs. Each tab has relevant commands that are organized, grouped, and labeled. An example of a typical user interaction is as follows:

"Click **Draw > Line**"



This instruction means that you should click the **Line** command on the **Draw** ribbon tab. An image of the command icon, or a partial view of the ribbon, is often included with the instruction.

- The *menu bar* (located above the ribbon) is a group of the main commands of an application arranged by category such File, Edit, View, Project, etc. An example of a typical user interaction is as follows:

"On the **File** menu, click the **Open Examples** command" means you can click the **File** menu and then click **Open Examples** to launch the dialog box.

- Another alternative is to use the *shortcut menu* that appears when you click the right-mouse button. An example of a typical user interaction is as follows:

"Right-click and select **Assign Excitation > Wave Port**" means when you click the right-mouse button with an object face selected, you can execute the excitation commands from the shortcut menu (and the corresponding sub-menus).

Getting Help: Ansys Technical Support

For information about Ansys Technical Support, go to the Ansys corporate Support website, <http://www.ansys.com/Support>. You can also contact your Ansys account manager in order to obtain this information.

All Ansys software files are ASCII text and can be sent conveniently by e-mail. When reporting difficulties, it is extremely helpful to include very specific information about what steps were taken or what stages the simulation reached, including software files as applicable. This allows more rapid and effective debugging.

Help Menu

To access help from the Help menu, click **Help** and select from the menu:

- **[product name] Help** - opens the contents of the help. This help includes the help for the product and its *Getting Started Guides*.
- **[product name] Scripting Help** - opens the contents of the *Scripting Guide*.
- **[product name] Getting Started Guides** - opens a topic that contains links to Getting Started Guides in the help system.

Context-Sensitive Help

To access help from the user interface, press **F1**. The help specific to the active product (design type) opens.

You can press **F1** while the cursor is pointing at a menu command or while a particular dialog box or dialog box tab is open. In this case, the help page associated with the command or open dialog box is displayed automatically.

Table of Contents

Table of Contents	Contents-1
1 - Introduction	1-1
Prerequisites	1-1
What You Will Learn	1-1
HFSS Optimetrics	1-2
T-Junction Recap and Sample Project Overview	1-3
2 - Set Up the Optimized Tee	2-1
Open the Model	2-1
Enable Legacy View Orientations	2-2
Delete the Frequency Sweep	2-4
Add a Parametric Setup	2-4
Specify Quantities for Post Processing	2-8
Solve the Parametric Analysis	2-12
3 - Review Parametric Results	3-1
S-Parameter Results vs. Septum Offset	3-1
Power Distribution vs. Offset Position	3-4
Animate the Field Overlay	3-7
4 - Optimization Analysis	4-1
Set the Optimization Variable	4-1
Add an Optimization Setup	4-1
Add a Cost Function	4-2
Modify Starting, Min, and Max Values	4-4
Solve the Optimization Analysis	4-4
5 - Review the Optimization Results	5-1
View the Cost vs. Solved Iteration	5-1
Optional Exercise:	5-2
Reanalyze Design at Optimal Septum Offset	5-4
Update the Field Overlay	5-5

Close the Project	5-5
6 - Optionally, Restore Current View Orientations	6-1

1 - Introduction

This document describes how to optimize the model created in the previous *Waveguide T-Junction* getting started guide. It includes instructions to set up and solve a basic parametric analysis and to create and solve an optimization setup.

This chapter contains the following topics:

- Prerequisites
- What You Will Learn
- HFSS Optimetrics
- T-Junction Recap and Sample Project Overview

Prerequisites

We strongly recommend that you complete the tutorial *Getting Started with HFSS: A Waveguide T-Junction* before you work on this exercise. The parametric and optimization setups for this project are based on the design setup, analyses, and post processing performed in the Waveguide T-Junction tutorial. However, an example *Tee* model is included as part of the Ansys Electronics Desktop installation. It is identical to the model created via the prerequisite guide, except that the results have not been computed yet. However, the analysis setup, sweep, S-parameter plot, and E-field overlay are already defined. If you choose to complete this exercise without completing the prerequisite tutorial, the example *Tee* model provides the means to do so.

What You Will Learn

You will learn to perform the following HFSS tasks in the Ansys Electronics Desktop application:

- Create a basic parametric setup.
- Solve a parametric analysis.
- Create a 2D x-y plot of S-parameter results.
- Create a 2D x-y plot of power distribution results.
- Create a geometry animation.
- Specify an optimization variable.
- Create an optimization setup, which includes defining a cost function and setting the range of variable values for an optimization.
- Run an optimization analysis.
- During an optimization analysis, create a plot of cost values versus solved iterations.
- Run an HFSS simulation using the optimal variable value.
- Update an existing field overlay plot with new results.

HFSS Optimetrics

Optimetrics is a feature that automates the process of determining the best design variation among a number of possible options. Create the original model and define the design parameters that vary. These parameters can be nearly any design characteristic assigned a numeric value in HFSS. For example, you can parameterize the model geometry, material properties, or boundary conditions. You can then perform the following types of analyses on your nominal design:

Parametric	Define one or more <i>variable sweep definitions</i> , each specifying a series of variable values within a range, and HFSS solves the design at each variation. Parametric analyses are often used as precursors to optimization solutions because they help to determine a reasonable range of variable values for the optimization analysis.
Optimization	Identify the cost function and the optimization goal. Optimetrics changes the design parameter values to meet that goal.
Sensitivity	Optimetrics explores the space in the vicinity of the design point to determine the sensitivity of the design to small changes in variables.
Tuning	Tuning allows you to change variable values interactively while monitoring the performance of the design.
Statistical	Optimetrics allows you to explore the effects of various combinations of selected variables on specified analysis results. These effects are presented as a statistical distribution of a user-specified type (such as Uniform, Gaussian, or other types).
Design of Experiments	Design of Experiments (DOE) is a technique used to scientifically determine the location of sampling points and is included as part of the Response Surface, Goal Driven Optimization, and Analysis systems.
DesignXplorer	An optimization tool, used with Design of Experiments (DOE), for studying a range of design variations. It can launch Ansys Electronics Desktop and manage DOE and optimization simulations.

Note:

In this guide, you will perform a *Parametric* analysis and an *Optimization* analysis.

T-Junction Recap and Sample Project Overview

In this topic, we review the *Getting Started with HFSS: A Waveguide T Junction* exercise, which is a prerequisite to this optimization exercise. We also discuss the sample model for the optimization and the expected results.

Recap of the Tee Waveguide Junction Project:

In *Getting Started with HFSS: A Waveguide T-Junction*, you created a T-shaped waveguide with an inductive septum.^[1] A signal at a frequency of 10 GHz entered the waveguide at Port1 (see below) and exited at Port2 and Port3.

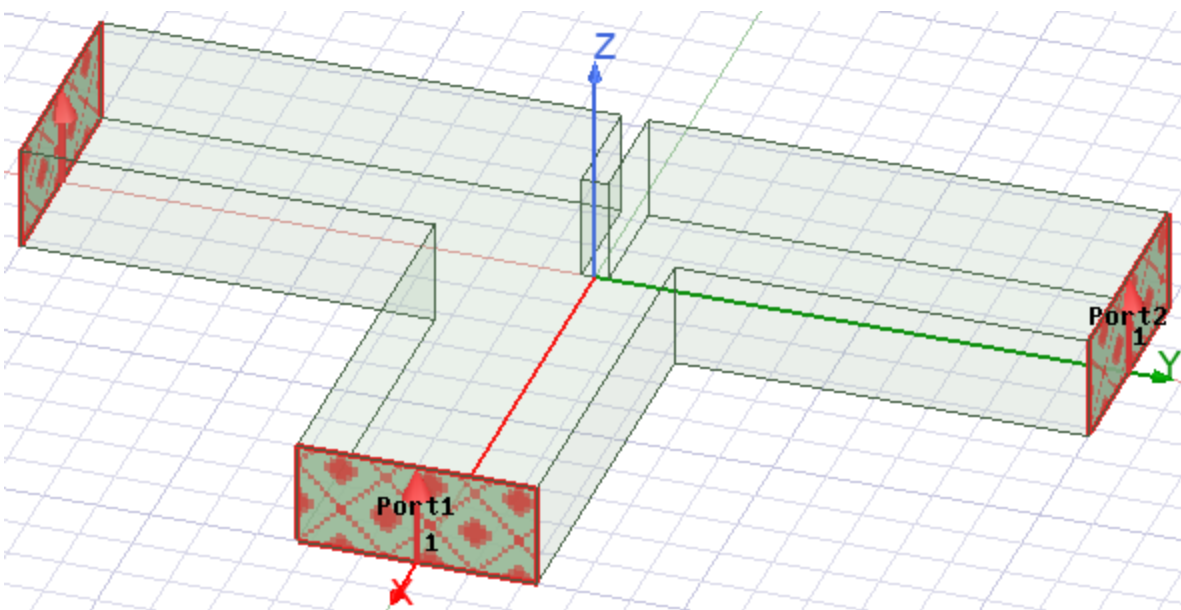

Figure 1-1: The T-Junction

The waveguide's transmission and reflection of the signal depended on the Y-position of the septum. You assigned a variable to the septum's position, named *Offset*, and solved the design at two *Offset* values. When the septum was located centrally between Port2 and Port3, opposite Port1 (*Offset* = 0 inches), the septum divided the signal and directed it evenly toward the output ports, Port2 and Port3. When the septum was moved 0.2 inches closer to Port2 (*Offset* = 0.2 inches), the transmission through Port2 decreased, and the transmission through Port3 increased. Also, the signal reflection at Port1 decreased somewhat with the septum in the offset position.

[1] "Parametrics and Optimization Using Ansoft HFSS," Microwave Journal, Product Reviews, November 1999.

Sample Project: Tee Waveguide Optimization

In this project, use the Optimetrics feature in HFSS to find an optimal position for the septum as defined by the *Offset* variable. The optimal position is that which results in the power distribution at Port3 being twice that at Port2. The function of this power distribution (that is, $P_{31} - 2 \cdot P_{21}$) is called the cost function. At a resultant cost of **zero**, $P_{31} = 2 \cdot P_{21}$, which is the design objective. In Optimetrics, we want to select the optimal position from a series of available alternatives and solve the corresponding designs until the minimum cost is achieved. One such series of available alternatives is the range of values for the offset.

Note:

The cost function can be based on any solution quantity that HFSS can compute, such as field values, S-parameters, and eigenmode data.

Important:

To preserve your previous *Tee* model, you will save a copy of it with a new name (*OptimTee*). Alternatively, if you choose to use the preinstalled *Tee* example model, you must save it as *OptimTee* to a working folder of your choice, since writing to the *Examples* folders is not permitted.

Before optimization, you will set up and solve a parametric analysis. The parametric setup will define a range of values for the *Offset* variable. During the parametric analysis, Optimetrics solves the design at each variation. Results are compared to see how each design variation affects the S-parameters and power distribution within the structure. These results help ascertain a range of *Offset* values for the subsequent optimization analysis. The results also help Optimetrics determine an acceptable starting point for the optimization analysis.

Expected Results:

We saw in the *Waveguide T-Junction project* that, when the septum is located centrally opposite to Port1, it directs the signal evenly toward the output ports, Port2 and Port3. The parametric analysis is expected to show that as the septum moves closer toward Port2, the transmission and power distribution initially decrease at Port2 and increase at Port3. As the septum continues to move closer toward Port2, the signal should begin to bounce off of the T-junction wall opposite Port1, more of the signal will be reflected, and the performance of the structure will degrade.

To verify whether the parametric results are as expected, compare the S-parameter calculations at each septum position on a 2D x-y plot. Create a second x-y plot that compares the power distribution at each port as the septum changes position. You can also create an animated field plot on the model geometry, which will indicate if the field pattern changes are as expected as the

septum's position is changed. This parametric analysis post processing provides useful information for setting up the optimization analysis that follows. For example, post processing should reveal the septum position that will most likely result in the power distribution at Port3 being twice that at Port2. It will also allow you to narrow the range of variable values you will set for the optimization.

The optimization analysis should reveal that the optimal septum position lies between 0 and 0.2 inches. You will re-analyze the design at the optimal position and then update the field overlay plot you created in the previous project (Waveguide T-Junction). The E-field values should indicate that the fields are twice as great moving toward Port 3 as they are moving toward Port 2.



2 - Set Up the Optimized Tee

This chapter contains the following topics:

- Open the Model
- Enable Legacy View Orientations
- Delete Frequency Sweep
- Add Parametric Setup
- Specify Quantities for Post Processing
- Solve the Parametric Analysis

Open the Model

Your actions in this procedure depend on whether you've completed the prerequisite tutorial, *Getting Started with HFSS: A Waveguide Tee Junction* and, if so, whether that model is already open.

1. Launch the Ansys Electronics Desktop application if it is not already running.
2. Close any open projects except for the prerequisite tutorial's *Tee* model (right-click the project and choose **Close** from the shortcut menu).
3. Choose one of the following three actions:
 - If you've completed the prerequisite tutorial and have proceeded directly to this exercise with the model still open, skip to step 4.
 - If you previously completed the prerequisite tutorial, but the model is no longer open, click  **Open** on the **Desktop** ribbon tab, navigate to your model storage location, and select **Tee.aedt**. Then click **Open** to load the model.
 - If you have not completed the prerequisite tutorial, click  **Open Examples** on the **Desktop** ribbon tab, double-click the **HFSS** subfolder under *Examples* in the *Open* dialog box, and then double-click the **RF Microwave** subfolder. Finally, select the file **Tee.aedt** and click **Open** to load the model.
4. On the **Desktop** ribbon tab, click  **Save As**.

The *Save As* dialog box appears.
5. Navigate to a working folder of your choice where you want to store the optimization model files.
6. In the **File name** text box, specify **OptimTee**.
7. Click **Save**.

Note:

There are a couple of inconsequential differences between the model built in the pre-requisite tutorial and the preinstalled example model:

- The images included in this guide were captured from the model built in the pre-requisite tutorial and are based on the software's default material appearance attributes at that time. The material color and transparency attributes of the pre-installed example model are different. Therefore, if you are using the preinstalled example model, the color and transparency will differ from the images in this guide.
- The initial position of the Septum depends on which model you open. At the end of the previous tutorial, the Septum is at an offset position (specifically, 0.2 inches off-center, moved toward Port2). However, the example model has the Septum at the zero-offset position (centered between Port2 and Port3).

Since you will specify the range of offset values for the subsequent parametric analysis, the initial position of the Septum is inconsequential.

Enable Legacy View Orientations

This getting started guide was created based on standard view orientations that were in effect for version 2023 R2 and earlier of the Ansys Electronics Desktop application. For consistency between your experience and the views and instructions contained in this guide, select the *Enable Legacy View Orientation* option in the 3D UI Options dialog box, as follows:

1. From the menu bar, click **View > Options**.

The *3D UI Options* dialog box appears.

2. Select **Enable Legacy View Orientation**:

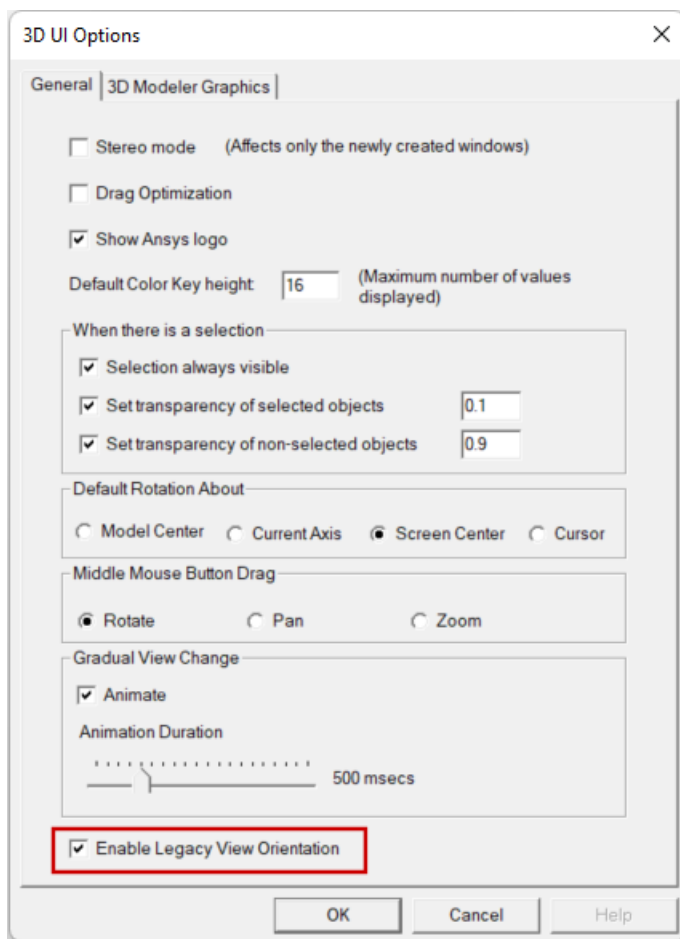

3. Click **OK**.

Changing the view orientation option does not change the model viewpoint that was in effect at the time.

4. On the **Draw** ribbon tab, click  **Orient** to change to the *Trimetric* view, which is the default legacy view orientation.

You do not have to select *Trimetric* from the *Orient* drop-down menu. The default view appears when you click *Orient*.

Although this option can only be accessed once a design is added to a project, it is a global option. Your choice is retained for all future program sessions, projects, and design types that use the 3D Modeler or that produce 3D plots of results.

At the end of this guide, you will be prompted to clear the *Enable Legacy View Orientation* option, if you prefer to use the view orientation scheme implemented for 2024 R1 and newer versions going forward.

For a comparison of the legacy and current view orientations, search for "View Options: 3D UI Options" in the HFSS help. Additionally, views associated with **Alt + double-click** zones have

been redefined. The current orientations are shown in the help topic, "*Changing the Model View with Alt+Double-Click Areas.*"

Delete the Frequency Sweep

When you solve the parametric and optimization analyses later in this guide, you will solve at the solution frequency specified in the *Driven Solution Setup* dialog box (10 GHz) as part of the prerequisite T-Junction Waveguide exercise. You do not need to solve across a range of frequencies for each design variation. You will optimize the Tee at a fixed frequency of 10 GHz. Therefore, delete the previously defined frequency sweep, as follows:

1. Under *Analysis* > *Setup1* in the Project Manager, right-click **Sweep1** and select **Delete** from the short-cut menu:

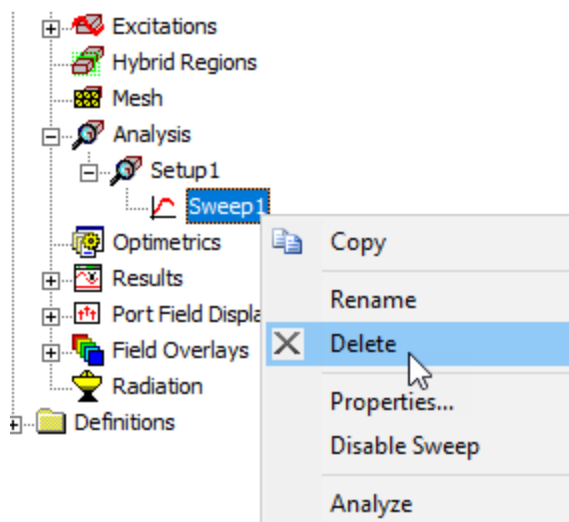

Figure 2-1: Deleting Frequency Sweep

2. If you are using the unsolved T-Junction model included in the *Examples* folder, run the adaptive solution as follows:
 - Under *Analysis* in the Project Manager, right-click **Setup1** and choose **Analyze**.



Wait until the initial solution has completed before continuing.

Proceed to the next page to begin setting up the parametric analysis.

Add a Parametric Setup

A *parametric setup* specifies all of the design variations that Optimetrics will drive HFSS to solve. A parametric setup is made up of one or more *variable sweep definitions*, each specifying a set of variable values within a range that you want HFSS to solve when you run the parametric setup.

You can add the parametric setup to the project as follows:

1. On the **Simulation** ribbon tab, click  **Optimetrics** >  **Parametric**.
Alternatively, you can right-click **Optimetrics** in the Project Manager and choose **Add > Parametric** from the short-cut menu.

The *Setup Sweep Analysis* dialog box appears.

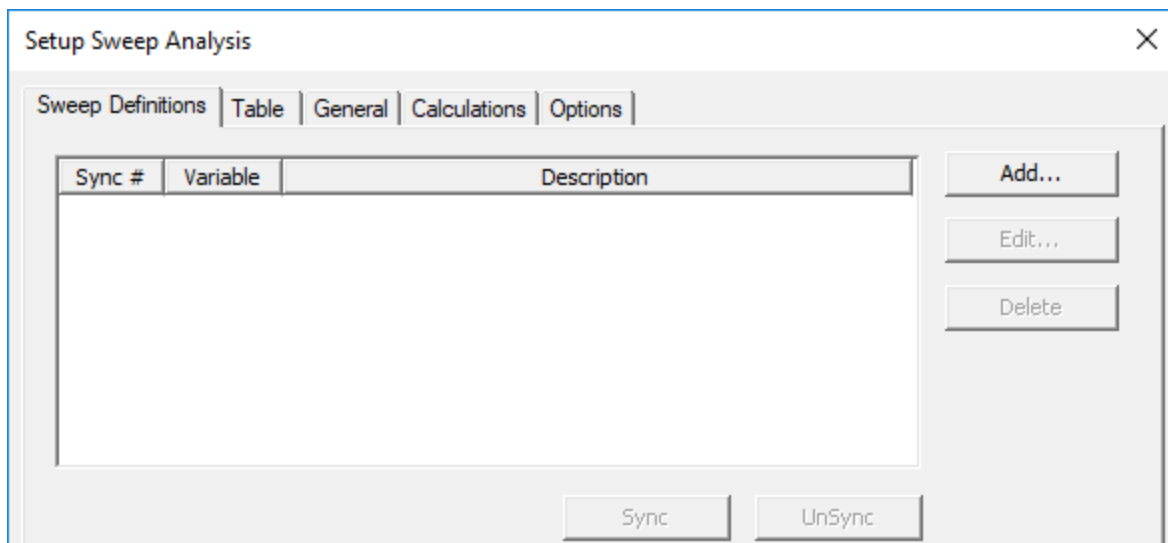

Figure 2-2: Setup Sweep Analysis Dialog Box

2. Click **Add**.
The *Add/Edit Sweep* dialog box appears.
3. Edit the entries as shown in the following figure:

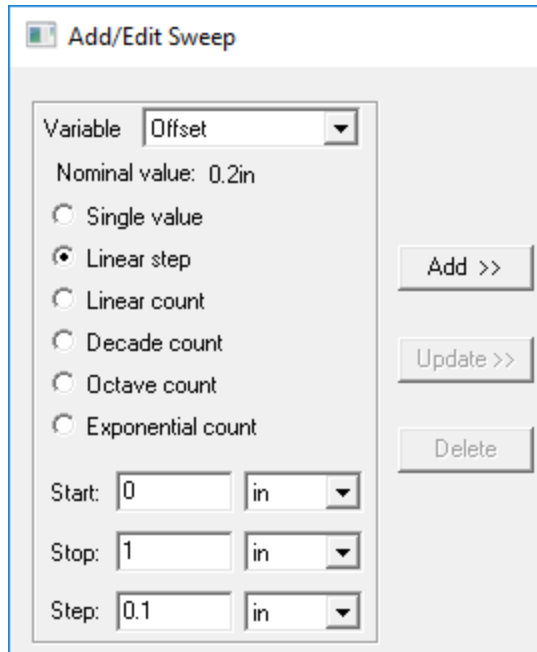

Figure 2-3: Add/Edit Sweep Dialog Box

Note:

The *Step* value is the calculation increment and determines the number of design variations between the *Start* and *Stop* values. HFSS will solve the model at each step in the specified range, including the *Start* and *Stop* values.

4. Click **Add >>** to create the parametric sweep setup.

The *Variable* and *Description* appear in the right half of the dialog box:

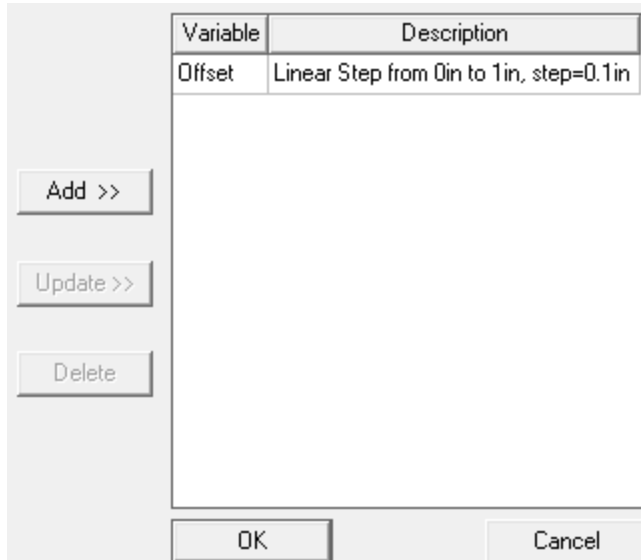

Figure 2-4: Parametric Sweep Variable and Description

5. Click **OK**.

The sweep setup appears in the *Setup Sweep Analysis* dialog box:

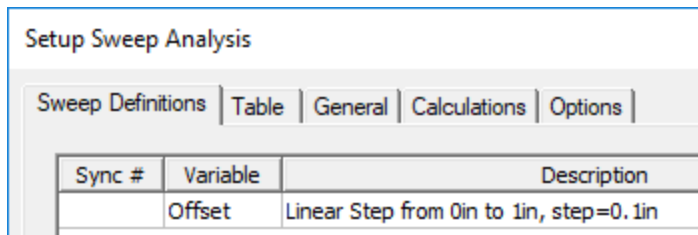
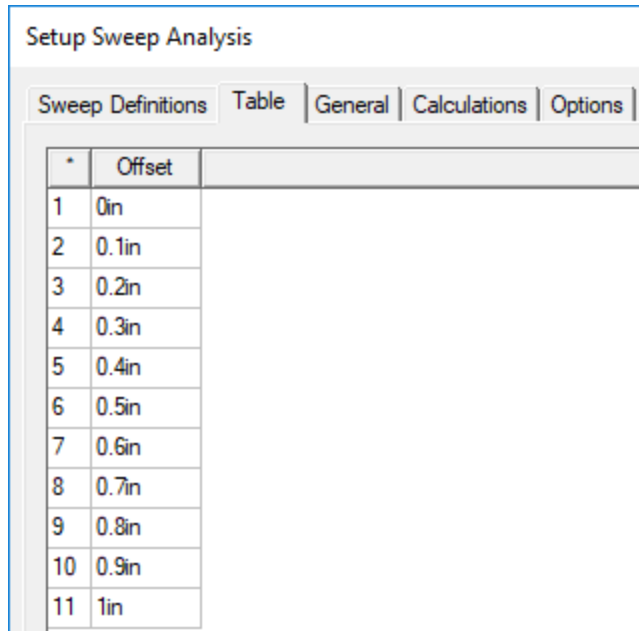

Figure 2-5: Parametric Sweep Added

6. Select the **Table** tab.

The table lists the different values of offset per your settings.



*	Offset
1	0in
2	0.1in
3	0.2in
4	0.3in
5	0.4in
6	0.5in
7	0.6in
8	0.7in
9	0.8in
10	0.9in
11	1in

Figure 2-6: Table Listing Offset Values

- Under the **Options** tab, select the **Save Fields and Mesh** option:

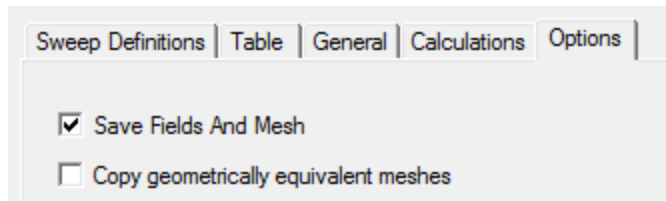

Figure 2-7: Setup Sweep Analysis – Options Tab

- Leave the *Setup Sweep Analysis* dialog box open. You will continue to use it in the next topic.

Specify Quantities for Post Processing

You will now identify three solution quantities that will be of interest during post processing. HFSS will extract the solution quantities and make them available during post processing. You will create three output variables that represent the mathematical expressions for the power distribution quantities at Port1, Port2, and Port3.

- If you did not leave the Setup Sweep Analysis dialog box open from the preceding topic, double-click **ParametricSetup1** under *Optimetrics* in the Project Manager to reopen it.
- Select the **Calculations** tab.
- Click **Setup Calculations**.

The *Add/Edit Calculation* dialog box appears.

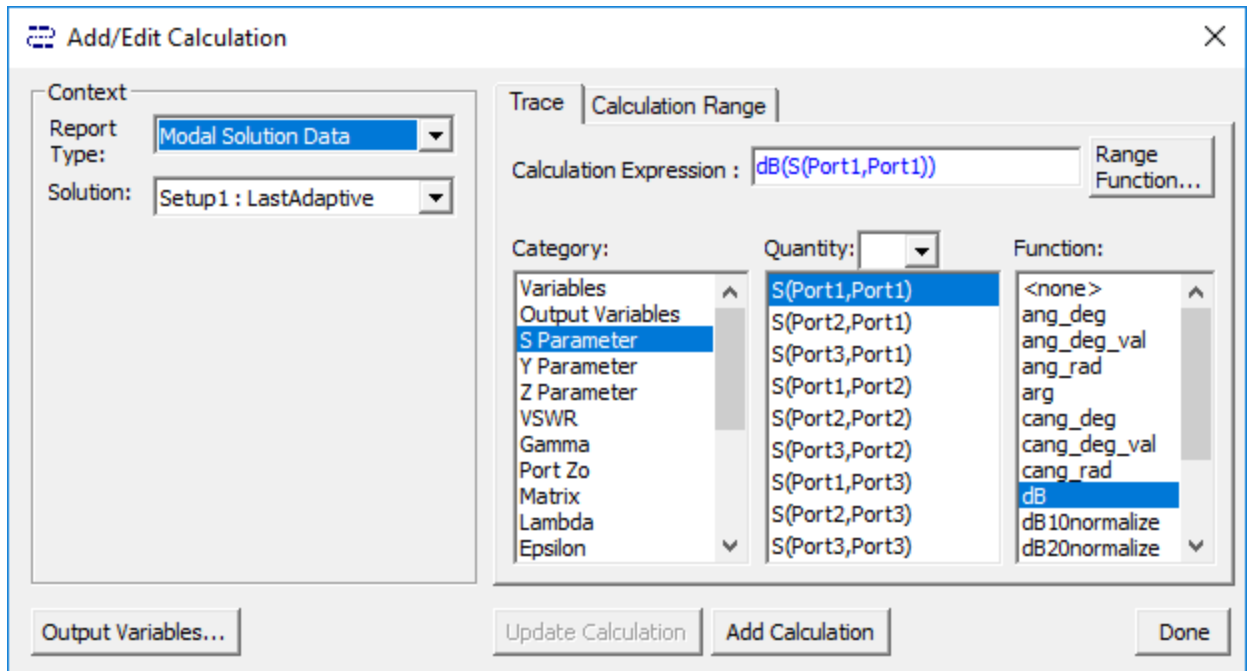

Figure 2-8: Add/Edit Calculation Dialog Box

4. Click **Output Variables**.

The *Output Variables* dialog box appears.

5. Make the following entries:
 - Type **Power11** in the **Name** field.
 - Select **S Parameter** from the **Category** drop-down menu.
 - Select **S(Port1,Port1)** in the **Quantity** list.
 - Select **mag** in the **Function** list.

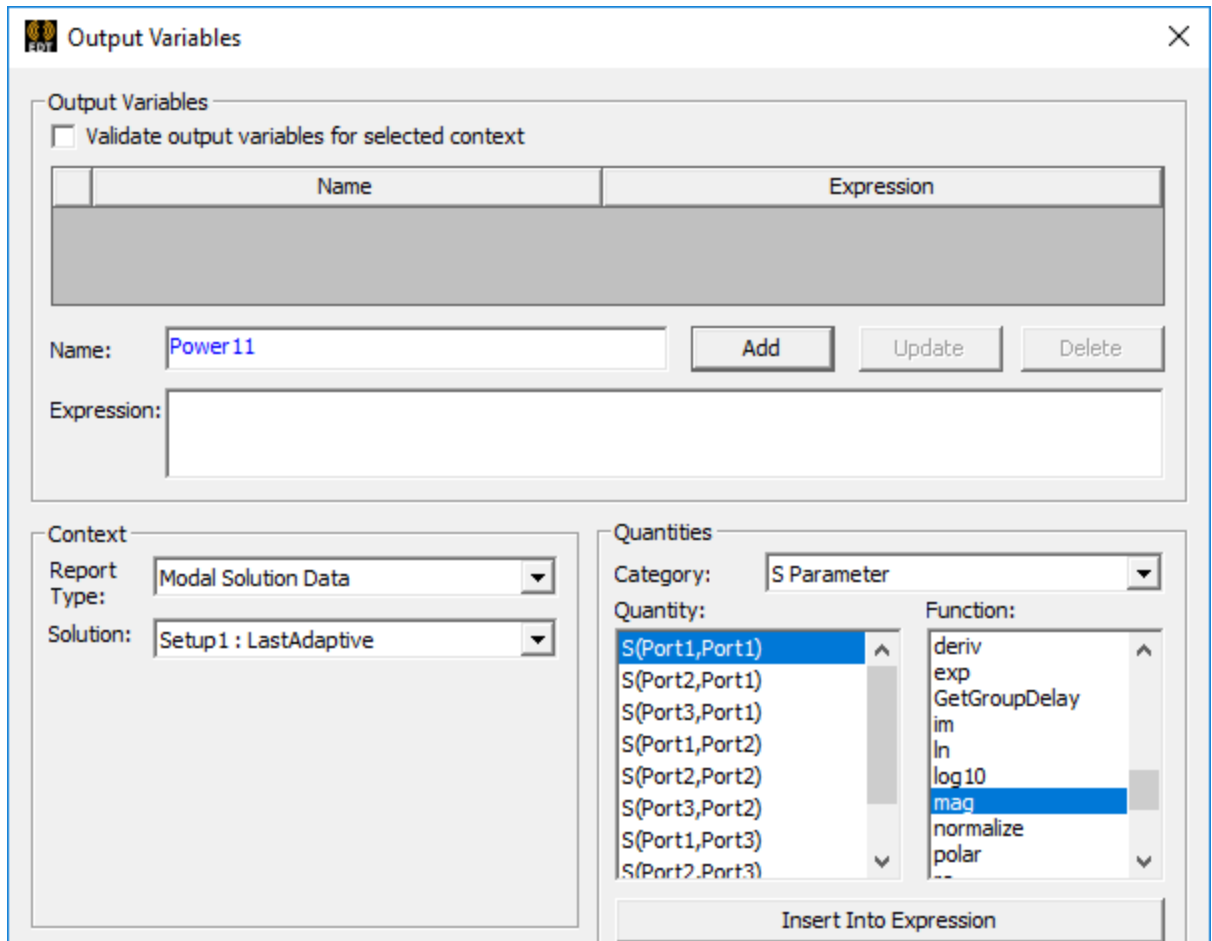

Figure 2-9: Defining *Power11* Output Variable

6. In the *Quantities* section, click **Insert Into Expression**.
7. In the **Expression** text box, type **^2** at the end of the expression (to square the S-parameter magnitude):

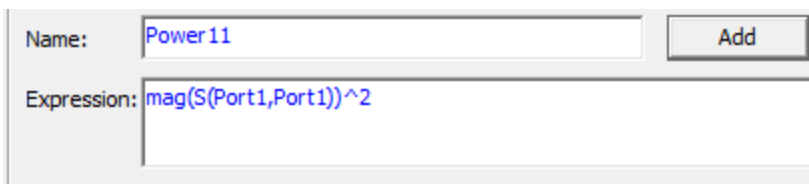

Figure 2-10: Modified *Power11* Expression

8. Click **Add** to include the specified variable in the *Output Variables* list.
9. In the same manner, define two more variables, *Power21* and *Power31*, as follows:

- a. **Power21** = $\text{mag}(S(\text{Port2},\text{Port1}))^2$
- b. **Power31** = $\text{mag}(S(\text{Port3},\text{Port1}))^2$

Note:

Click **Add** each time after defining the variables *Power21* and *Power31* to include them in the *Output Variables* list, which should look like the following figure when you're done:

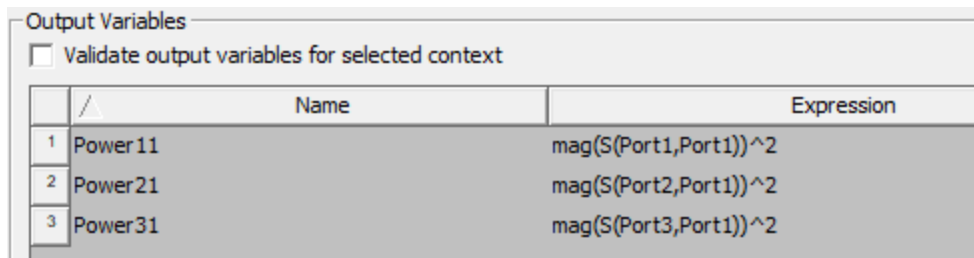

Figure 2-11: Output Variables

10. Click **Done**.

The *Output Variables* dialog box closes.

11. In the *Add/Edit Calculation* dialog box, select **Output Variables** in the **Category** list.

The *Trace* tab of the *Add/Edit Calculation* dialog box lists all of output variables you just defined, as shown in the following figure:

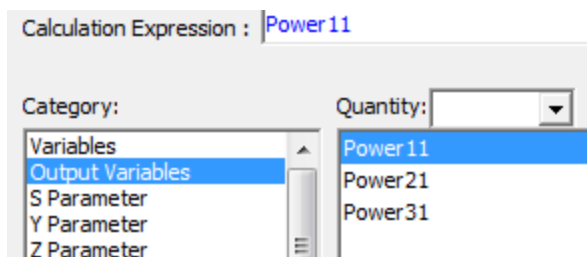

Figure 2-12: Calculation Expression tab

12. With **Power11** selected in the **Quantity** list, click **Add Calculation**.

Power11 is added to the table in the *Calculations* tab of the *Setup Sweep Analysis* dialog box.

13. In the same manner, select **Power21** and **Power31**, in turn, and add each of them to the *Calculations* table.

Sweep Definitions Table General Calculations Options			
	Solution	Calculation	Calculation Range
	Setup1 : LastAdaptive	Power11	Freq(10GHz)
	Setup1 : LastAdaptive	Power21	Freq(10GHz)
	Setup1 : LastAdaptive	Power31	Freq(10GHz)

Figure 2-13: Post Processing Quantities Defined for Parametric Sweep Analysis

Note:

By default, the calculation range is set to the single frequency 10 GHz (the adaptive frequency defined in the solution setup). So, the solution quantity will be extracted from the solution at this frequency.

- Click **Done** to close the *Add/Edit Calculation* dialog box and **OK** to close the *Setup Sweep Analysis* dialog box.

This step completes the parametric sweep setup definitions.

- It's a good time to  **Save** your model.

Solve the Parametric Analysis

You will now run the parametric analysis to generate results for the T-junction for different positions of the septum specified in the variable sweep definition.

- Right-click **ParametricSetup1** under *Optimetrics* in the Project Manager and click **Analyze** from the shortcut menu.

HFSS computes the S-parameters and the 3D field solution for every previously unsolved design variation that you specified in the parametric setup.

Note:

If the *Progress* window is not visible, click **Show Progress** at the lower right corner of the Ansys Electronics Desktop window.

The solution process is expected to take approximately 3 minutes. When the solution is complete, a confirmation message appears in the *Message Manager* window. To see the messages, you may need to click **Show Messages** near the lower right corner of the application window.

3 - Review Parametric Results

This chapter contains the following topics:

- S-Parameter Results vs. Offset Position
- Power Distribution vs. Offset Position
- Animate the Field Overlay Plot

You will begin by creating two rectangular plots of the results.

S-Parameter Results vs. Septum Offset

With the parametric setup solved, you can now create a 2D (rectangular) plot that compares the S-parameter results at each port for each solved septum position (*Offset*).

1. On the **Results** ribbon tab, click  **Modal Solution Data Report** >  **2D**.

The *Report* dialog box appears.

2. In the *Context* section, ensure that **Setup 1: Last Adaptive** is selected from the **Solution** drop-down menu.
3. Under the **Trace** tab, specify the following settings:
 - a. From the **Primary Sweep** drop-down menu, choose **Offset**.

Note:

By default, the variable is *Freq*, which HFSS recognizes as the frequency at which the solution was generated. For this exercise, you want the X-axis to show the sweep of all *Offset* values that were solved during the analysis.

- b. Ensure that **S Parameter** is selected in the **Category** list.
- c. In the **Quantity** list, select **S(Port1,Port1)**, **S(Port1,Port2)**, and **S(Port1,Port3)**.

Note:

The Y: text box lists the selected quantities, delimited by semi-colons.

- d. In the **Function** list, select **mag**.

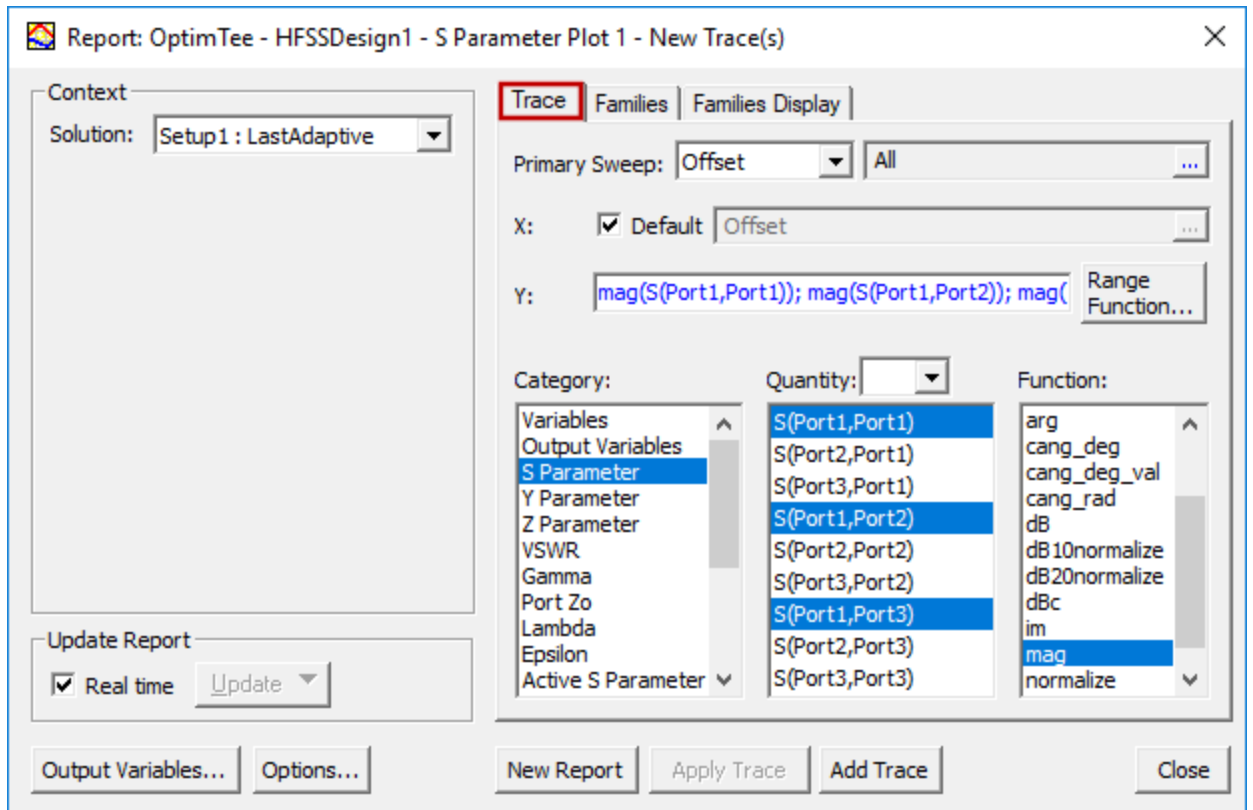

Figure 3-1: Report Dialog Box – Trace Tab

4. Ensure that **All** is specified to the right of *Primary Sweep: Offset*. If not, click the elipsis button (...) and select the **Use all values** option from the dialog box that appears.

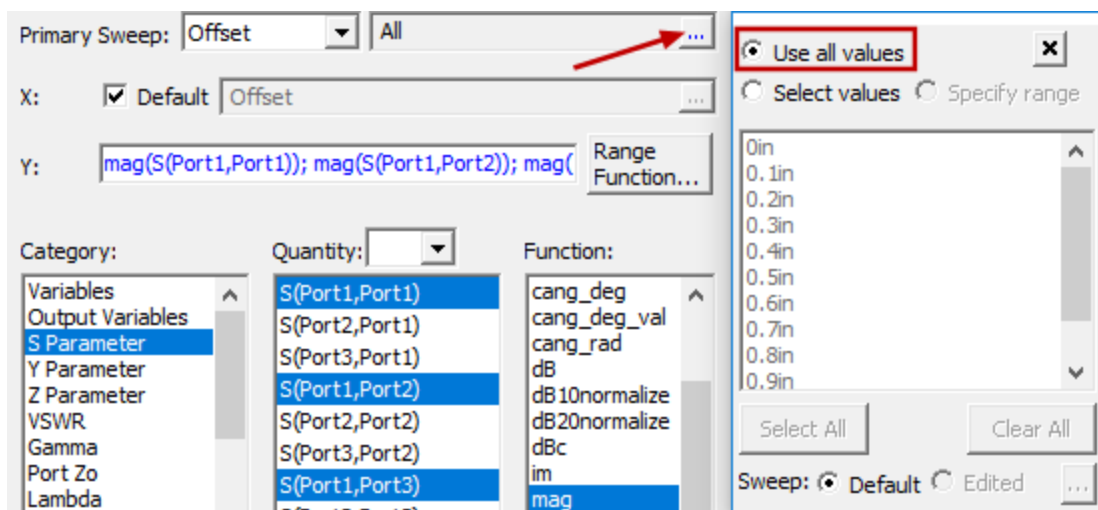

Figure 3-2: Report Dialog Box – Families Tab

- Click **New Report** but keep the *Report* dialog box open for now.

The magnitudes of each of the specified S-parameters are plotted against the *Offset* values on an X-Y graph. The new plot appears under *Results* in the Project Manager along with its three traces.

- If needed, drag the *Report* dialog box out of the way of the plot window so that you can modify and reposition the plot legend. But again, keep the *Report* dialog box open for now.
- Simplify the plot legend by double-clicking in the legend to access the plot *Properties* dialog box. Then, make the following changes under the *Legend* tab:
 - Deselect the **Show Variation Key** and **Show Solution Name** options.
 - Click **OK**.
 - Click and drag the legend to a location that doesn't obscure any of the traces.

Your plot should look like the following figure:

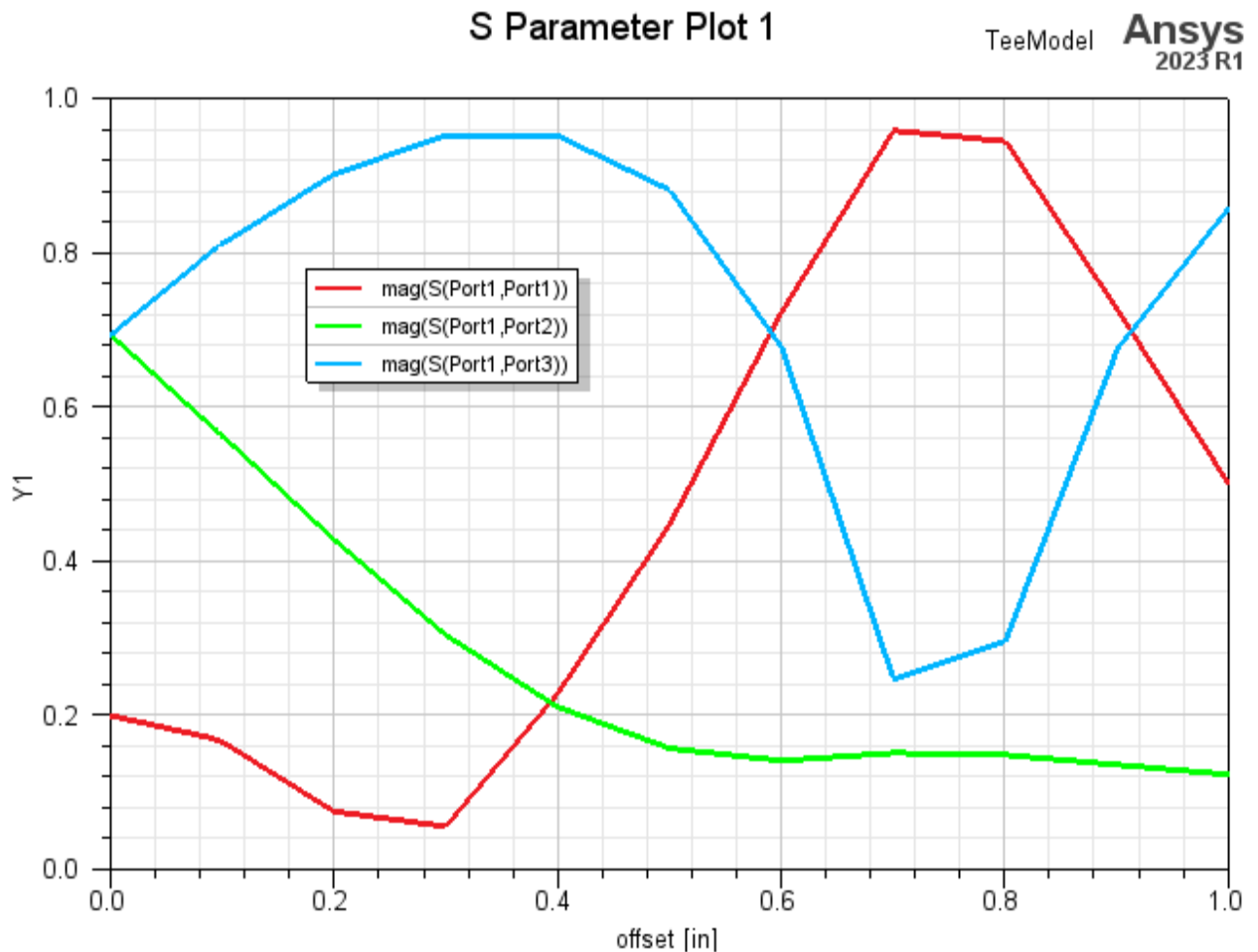

Figure 3-3: XY Plot – S Parameters vs. Septum Offset

Note:

For each value of *Offset*, the red line shows the signal reflection at Port 1, the green line shows the signal transmission to Port 2, and the blue line shows the signal transmission to Port3.

Observations:

- As the septum moves closer to Port2, the transmission decreases at Port2 and initially increases at Port 3.
- As the septum is moved more than 0.3 inches toward Port2, it becomes less effective at steering the signal toward Port3, and the transmission begins to decrease at Port3. Additionally, reflection increases at the input port (Port1) as the signal bounces back from the T-junction wall opposite the port.
- Beyond 0.6 inches of Offset, the effect on transmission at Port2 becomes relatively insignificant and the curve levels off.
- At 0.7 inches of Offset, the reflection at Port1 peaks and, beyond this offset, begins to decrease again. At the same time, the transmission at Port3 has reached its minimum and begins to increase again.

Power Distribution vs. Offset Position

Now you will create a 2D plot that compares the power distribution results at each port for each solved septum position (*Offset*). The *Report* dialog box should still be open from the prior plot definition procedure.

1. Specify the following settings in the *Report* dialog box:
 - a. In the **Category** list, select **Output Variables**.
 - b. In the **Quantity** list, select **Power11**, **Power21**, and **Power31**.

The Y text box lists the selected quantities, delimited by semi-colons.

- c. In the **Function** list, click **<none>**.

Note:

If you didn't leave the *Report* dialog box open from the previous plot definition procedure and had to repeat the 2D/Rectangular plot command, you will have to once again change the **Primary Sweep** setting to **Offset**. Otherwise, the prior plot settings are retained.

Your new plot settings should match the following figure:

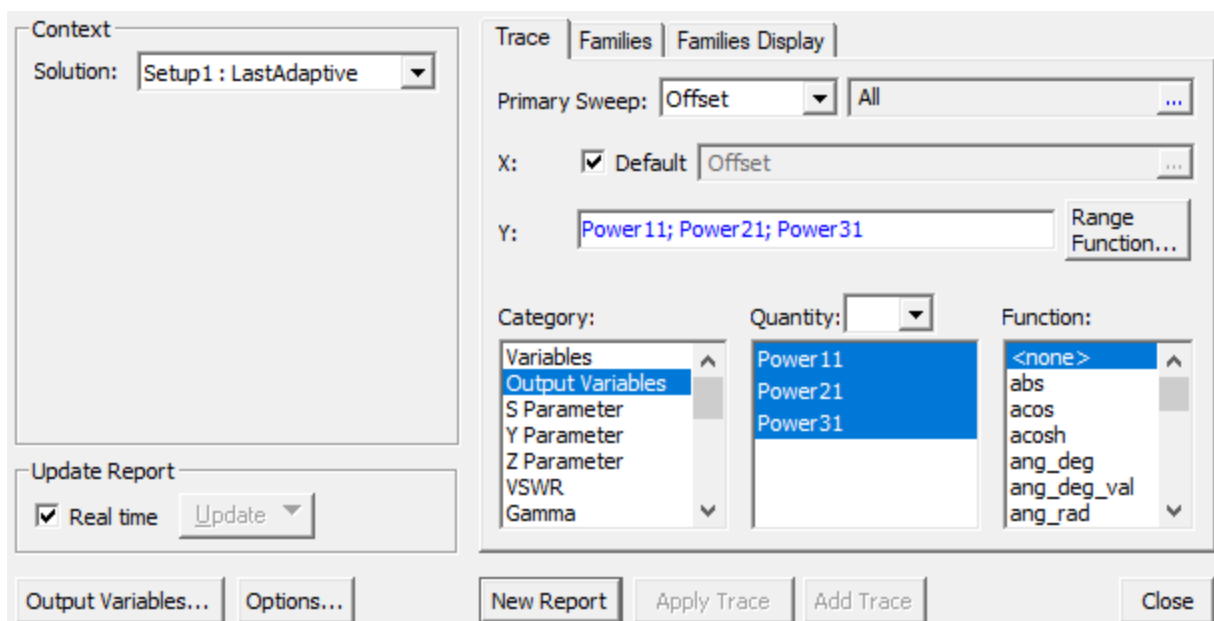

Figure 3-4: Report Dialog Box – Plot 2 Settings

2. Click **New Report** and **Close**.

The power distribution at each port is plotted against each *Offset* value on an X-Y graph. The new plot is listed under *Results* in the Project Manager along with its three traces.

3. Simplify the plot legend by double-clicking **Curve Info** in the legend to access the plot *Properties* dialog box. Then, make the following changes under the *Legend* tab:
 - a. Deselect the **Show Variation Key** and **Show Solution Name** options.
 - b. Click **OK**.
 - c. Click and drag the legend to a location that doesn't obscure any of the traces.

Your plot should look like the following figure:

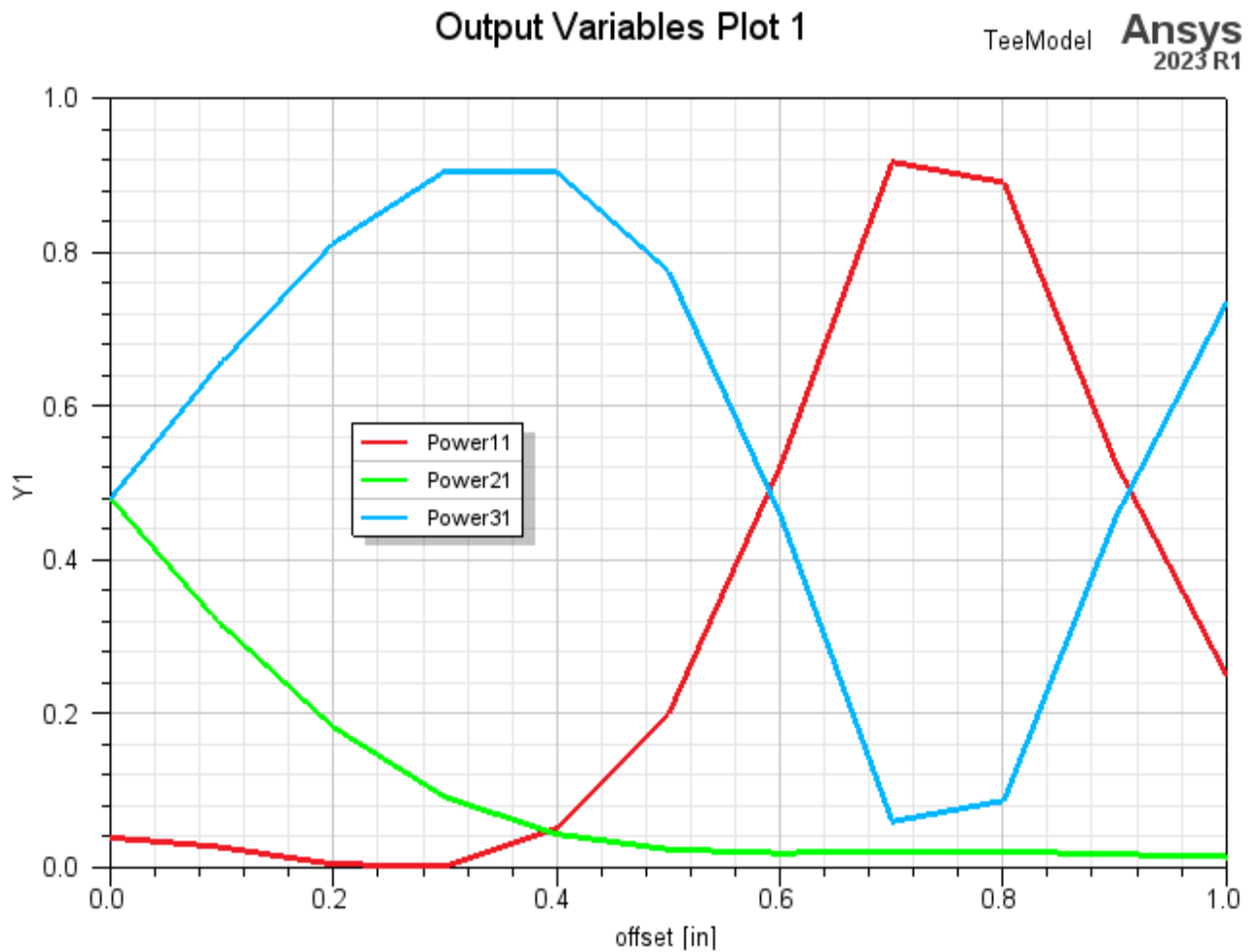

Figure 3-5: Power vs. Offset Plot

Note:

For each value of *Offset*, the red line shows the reflected power at Port1, the green line shows the power at Port2, and the blue line shows the power at Port3. The three traces are qualitatively the same as the previous S-parameter plot, but the magnitudes of the Y values are different. This plot shows the distribution of 1 watt of power at the ports as the septum's position moves closer to Port2.

Important:

Recall that the goal for the optimization analysis is to find the septum position that results in the power distributed to Port3 being twice as much as the power distributed to Port2. Notice that when the *Offset* is 0.1 inch, the value of Power21 is approximately 0.32, and Power31 is approximately 0.65, or slightly more than twice as much. Therefore, you will set the starting value for the optimization to be 0.1 inches. The next chapter includes more details about setting the starting value.

- You can add an X-marker to the plot to make determining the power levels at *Offset* = 0.1 inch easier. To do so, right-click the plot and choose **Marker > Add X Marker**. Then, drag the marker horizontally to choose the X value and see the corresponding Y values at any point along the traces, as shown below:

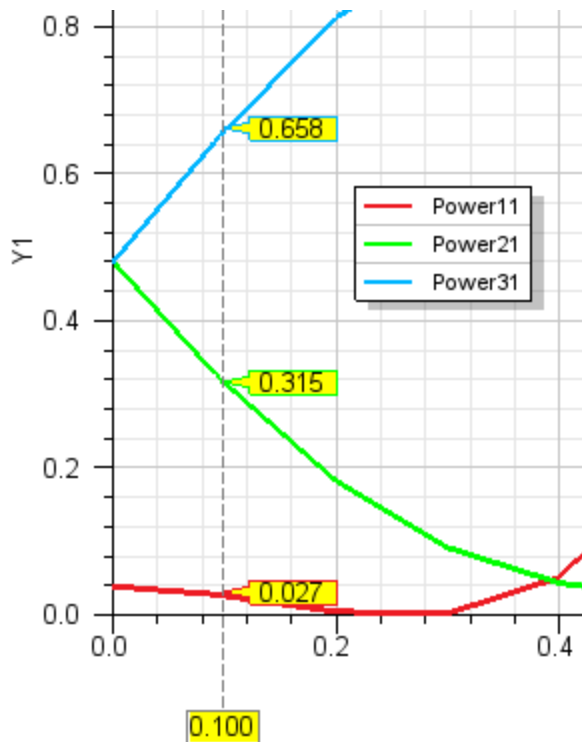



Figure 3-6: Using the X Marker

- To remove the X Marker, right-click on the plot and choose **Marker > Clear All**.

Animate the Field Overlay

Re-animate the field overlay plot you created in *Getting Started with HFSS: A Waveguide T-Junction*. This time, you will plot the E-field at each solved value of *Offset* to see how the field is

affected by the septum's position.

1. Click in the *Modeler* window to make it active and bring it to the foreground. If the *Modeler* window is completely covered by your plots, use the **Window** menu to select it.
2. If the drawing grid is currently displayed in the Modeler window, click  **Grid** on the **Draw** ribbon tab to hide it.
3. Under *Field Overlays* > *E Field* in the Project Manager, right-click **Mag_E1** and choose **Animate** from the shortcut menu.

If you based this model on a previously completed Waveguide T-Junction exercise, you already defined a phase animation, and the *Select Animation* dialog box appears. Otherwise, if no animation has been defined previously, the *Create Animation Setup* dialog box appears.

4. If the *Select Animation* dialog box appears, click **New** to define another animation setup. The *Create Animation Setup* dialog box appears.
5. Under the **Swept Variable** tab, choose **Single variable** and **Offset** from the two drop-down menus.

By default, all values of *offset* are selected to be included in the animation.

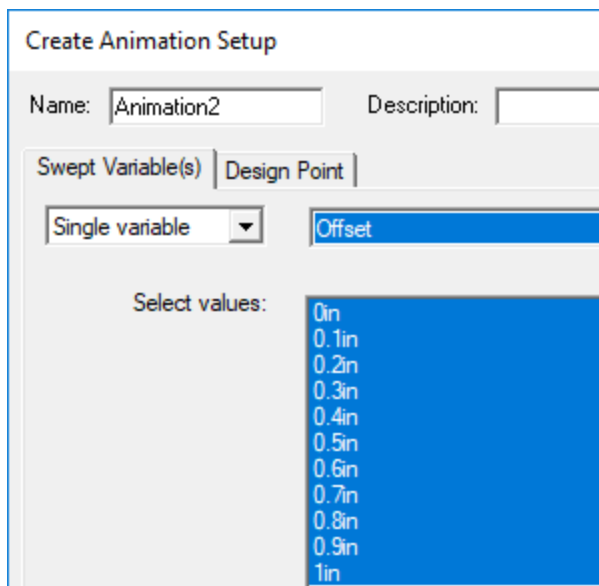

Figure 3-7: Create Animation Setup Dialog Box

6. Click **OK**.

The animation begins to play in the Modeler window. It will display the field plot at each solved *Offset* value between 0 and 1.0 inch, resulting in a total of 11 frames.

7. Reduce the animation **Speed** to its minimum setting so that you have time to see the field pattern for each septum position. You may also want to stop the animation and drag the *Frame* slider manually to study the results at specific *Offset* values.

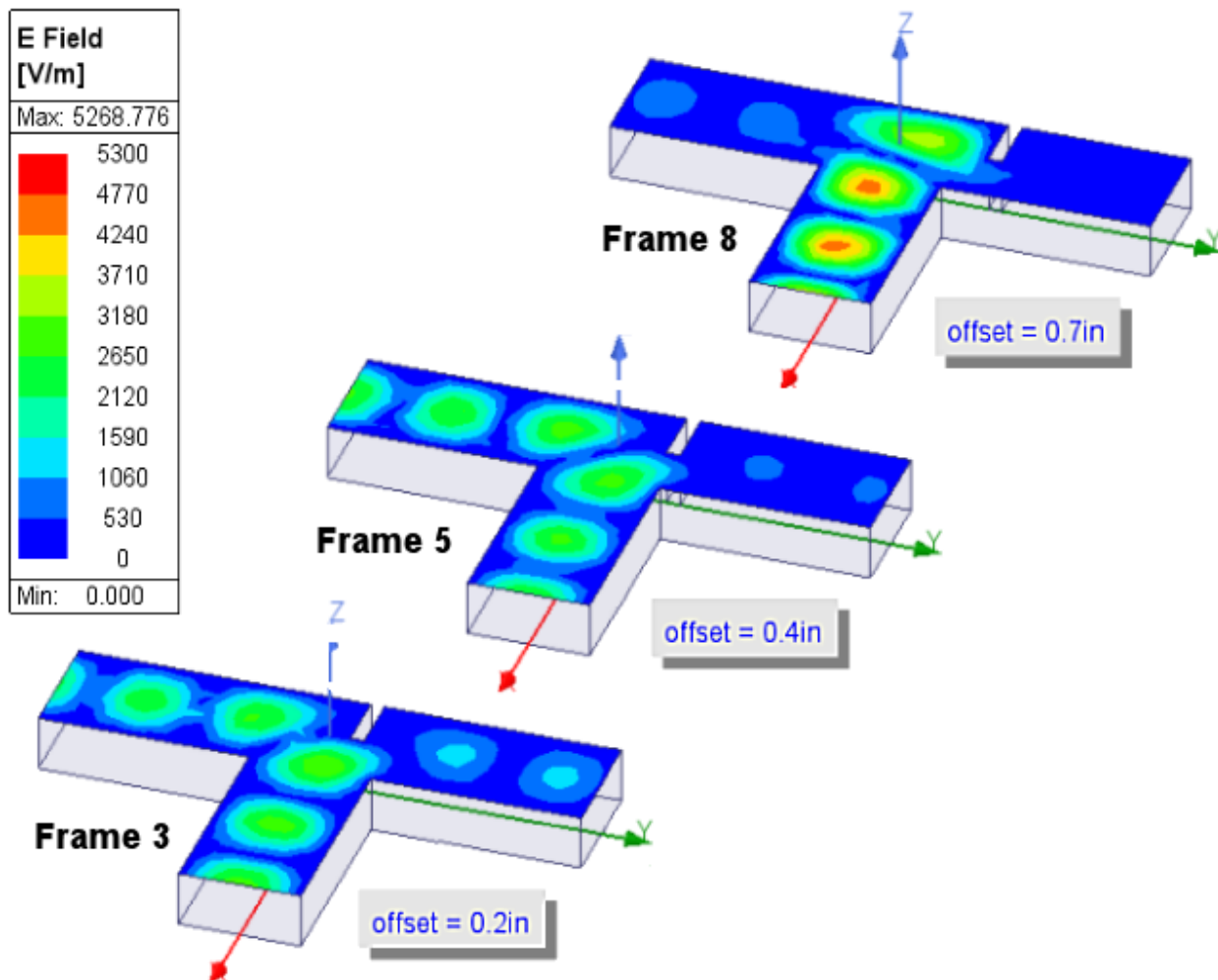

Figure 3-8: *Mag_E1* Field Animation at Three Septum Positions

Observations:

- The plot shows that, at *Offset* = 0 inch, the fields approaching Port2 and Port3 are balanced.
- When *Offset* is between 0.1 and 0.3 inches, inclusively, more of the electromagnetic wave moves toward Port3 (on the left) and less towards Port2 (on the right).
- At 0.5 inch *Offset*, essentially all of the input field flows to Port3 and none to Port2.
- At greater than 0.5 inch *Offset*, the input wave begins to bounce back toward Port1, as indicated by the intensified field strength in the middle leg of the tee. (The septum becomes less effective at steering the wave toward Port2 and Port3.)

Based on these observations, and knowing that the target solution should be close to *Offset* = 0.1 inch, you will request that Optimetrics only consider *Offset* values between 0 and 0.2 inch during the optimization analysis.

8. In the *Animation* dialog box, click **Close**.

You are now ready to set up the optimization analysis.

4 - Optimization Analysis

This chapter contains the following topics:

- Set the Optimization Variable
- Add an Optimization Setup
- Add a Cost Function
- Modify Starting Min, and Max Values
- Solve the Optimization Analysis
- Optional Exercise

You will begin by choosing the variable to be optimized.



Set the Optimization Variable

In this project, the variable to be optimized is *Offset*.

1. Click **HFSS > Design Properties**.
The *Properties* dialog box appears.
2. Click **Optimization / Design of Experiments**.
3. Select the **Include** option next to *Offset*.
4. Click **OK**.

Add an Optimization Setup

In an optimization setup, define a cost function, which specifies one or more goals and guidelines to minimize the cost function.

1. On the Simulation ribbon tab, click  **Optimetrics >  Optimization**.
The *Setup Optimization* dialog box appears.
2. Under the **Goals** tab, select **Quasi Newton (Gradient)** from the **Optimizer** drop-down menu.

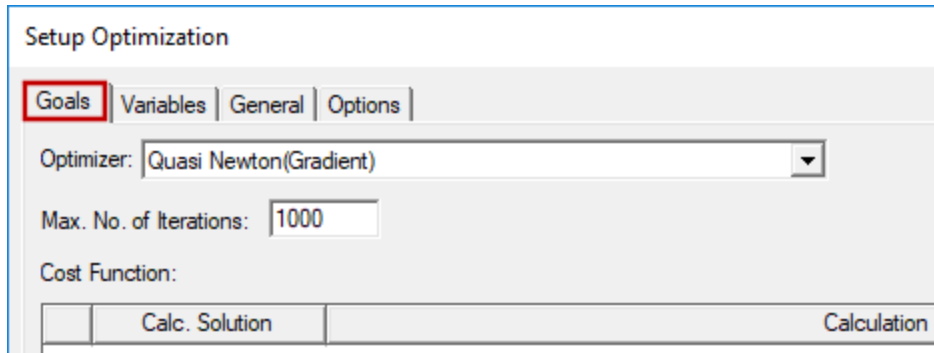

Figure 4-1: Optimizer and Max Iterations Settings

Note:

If you have a sense of where the optimal solution will lie, then Quasi Newton is a good choice. In this case, the cost function that needs to be minimized is dependent on the range of *Offset* values you specify. A range of 0 to 0.2 inch contains the expected optimal solution, which should be close to 0.1 inch.

3. Verify that **Max. No. of Iterations = 1000**.

Keep the dialog box open and continue to the next topic.

Add a Cost Function

Define a cost function so that the power at Port3 - 2*(the power at Port2) = 0 at the optimal point. Use the output variables defined earlier to represent this expression. Specify that a cost function value less than 0.001 is acceptable.

1. Under the **Goals** tab, click **Setup Calculations**.

The *Add/Edit Calculation* dialog box appears.

2. Select **Output Variables** in the **Category** list and **Power31** in the **Quantity** list.
3. Modify the **Calculation Expression** by appending **-2*Power21** to **Power31**. The complete expression should be **Power31-2*Power21**, as shown in the following figure:

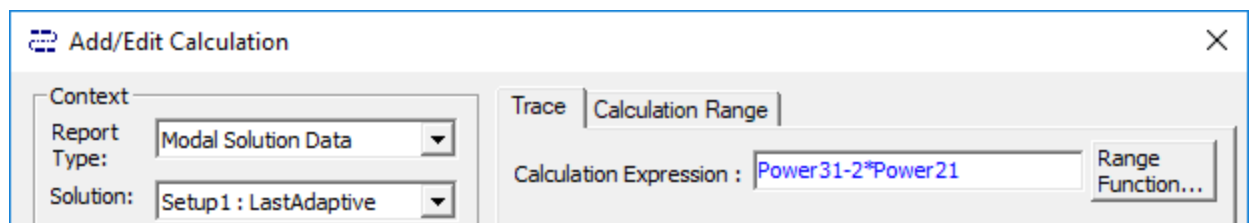

Figure 4-2: Add/Edit Calculation Dialog Box – Calculation Expression

4. Press **Add Calculation** and then **Done** to close the *Add Edit Calculation* dialog box.

A new row is added to the *Cost Function* table.

Note:

By default, the cost function will be extracted from the last adaptive solution generated for the solution setup.

5. Specify the following settings:
 - Leave **Condition** set to “=”.
 - In the **Goal** column, type **[0]** and press **Enter**.
 - In the **Weight** column, keep **[1]**.
 - In the **Acceptable Cost** text box, type **3e-4**.
 - In the **Noise** text box, type **5e-5**.

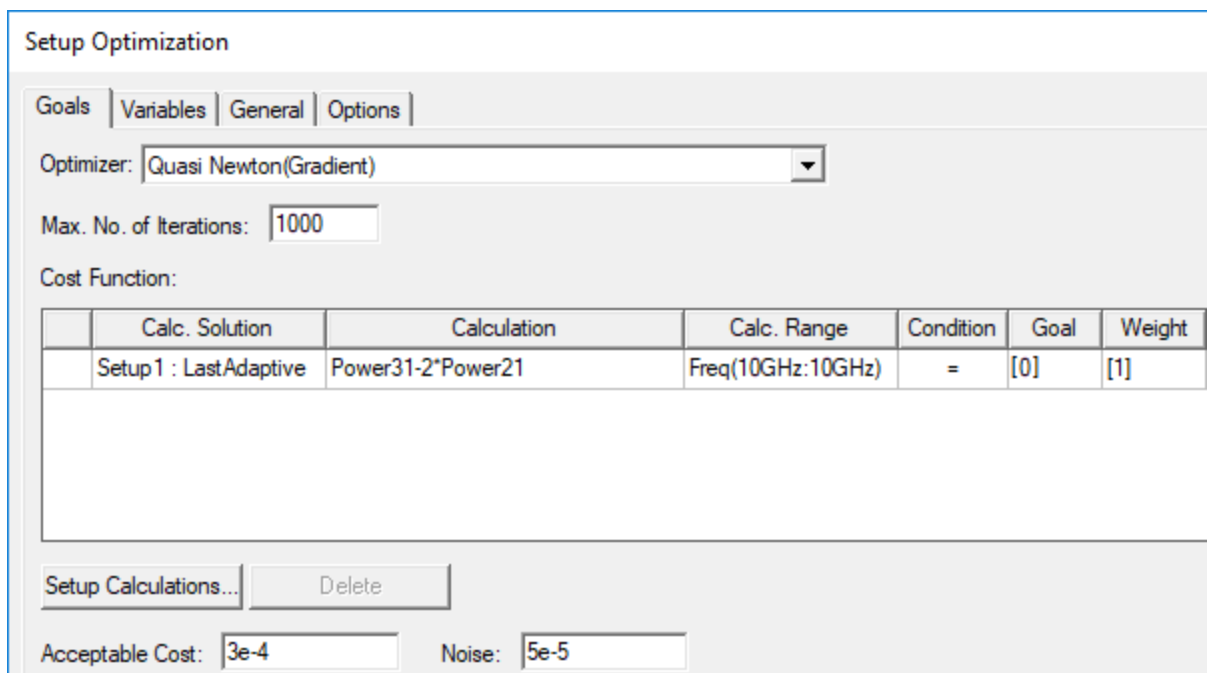

Figure 4-3: Cost Function Calculation added

Note:

By default, the calculation range of this quantity is set to 10 GHz, the adaptive frequency defined in the solution setup. The solution quantity will be extracted from the solution at this frequency.

Keep the dialog box open and proceed to the next topic.

Modify Starting, Min, and Max Values

We expect the optimum offset to fall between 0 and 0.2 inches and to be close to 0.1 inch. You can set the variable's minimum, maximum, and starting values accordingly so that the optimizer focuses closely on the expected solution area.

1. Select the **Variables** tab.

One variable, namely *Offset*, is listed under this tab, since it is the only optimization variable defined.

2. Specify the following settings for the Offset variable:

- a. Type **0.1** as the **Starting Value** and then press **Enter**.

The **Override** option is selected automatically, and Optimetrics will work with 0.1 regardless of the previous value of *Offset* used for the simulation.

- b. Type **0** as the **Min** value and press **Enter**.
- c. Type **0.2** as the **Max** value and press **Enter**.

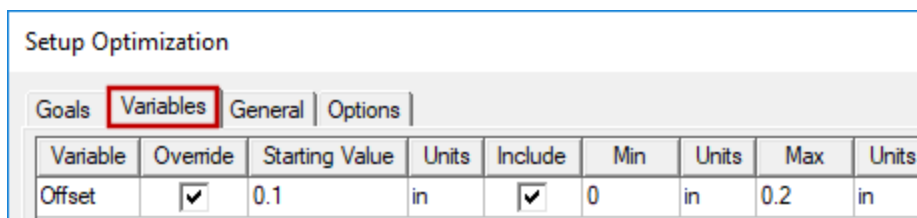

Figure 4-4: Setup Optimization Dialog Box – Variables Tab

3. Keep the dialog box open and proceed to the next topic.

Solve the Optimization Analysis

1. Select the **General** tab.
2. From the **Parametrics Analysis** drop-down menu, ensure that **N/A** (not applicable) is selected:

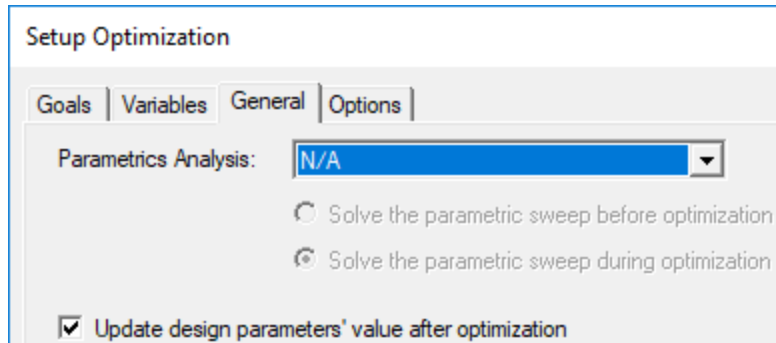

Figure 4-5: Setup Optimization Dialog Box – General Tab

Note:

If you were to choose the previously solved *ParametricSetup1*, the program would ignore the *Starting Value* for **Offset** that you specified under the *Variables* tab. Instead, it would evaluate the entire previous parametric sweep (including those offsets outside of the *Min* value to *Max* value range defined in *OptimizationSetup1*), and it would automatically determine a suitable starting point for the optimization iterations.

After running the optimization analysis, the analysis results table or plot will show the following information, depending on which **Parametrics Analysis** option you choose:

- **N/A:** The starting value will be 0.1, as specified as an *Override* under the *Variable* tab. (Note that the results at this septum offset already exist from the prior parametric sweep, so the cost can be evaluated without re-solving for this starting *Offset* value.) Three additional iterations (based on previously unsolved *Offset* values) will be performed before the goal is satisfied. The analysis results table will therefore show a total of four data points.
- **ParametricSetup1:** Every septum offset value from the previous parametric analysis results (between 0 and 1 inch, inclusively, in 0.1 inch increments) will be evaluated. Again, re-solving is not required but only cost evaluation for the already calculated results. These eleven *Offset* evaluations will be followed by two optimization iterations (based on previously unsolved *Offset* values) before the goal is satisfied. So, by taking advantage of the prior parametric sweep results, the goal is achieved with one fewer optimization iteration (even though the analysis results will show thirteen data points instead of four).

Note:

The additional *Offset* variants that are evaluated, and the final optimized value, will differ between these two methods, but both will satisfy the acceptable *Cost* criterion you specified (in this case, $3e-4$).

3. Ensure that the **Update design parameters' value after optimization** option is selected.

This option causes the model geometry to be updated with the optimized septum position at the completing of the optimization analysis.

4. Go to the **Options** tab and clear the **Save Fields And Mesh** option, if it is selected.

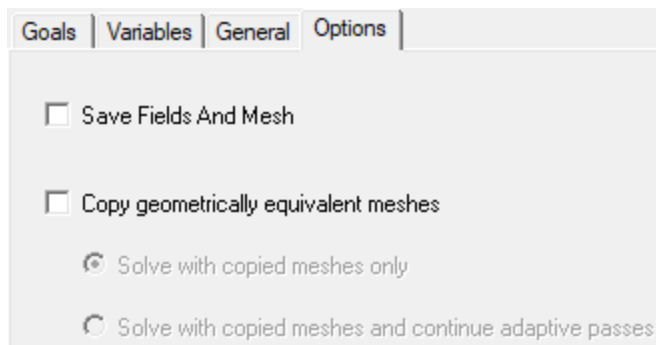

Figure 4-6: Setup Optimization Dialog Box – Options Tab

Note:

You do not need the field solutions for the *Offset* values that are solved as the program tries to reach the acceptable cost goal.

5. Click **OK** to close the *Setup Optimization* dialog box.

The optimization setup is now complete.

6. Under *Optimetrics* in the Project Manager, right-click **OptimizationSetup1** and choose **Analyze**.

The solution process is expected to take approximately 1 - 3 minutes, depending on your computer hardware. While the solution is running, proceed to the next chapter to follow the progress of *Optimetrics* as it searches for the acceptable cost value.

5 - Review the Optimization Results

In this chapter you will complete the following tasks:

- View the cost value versus completed iteration in x-y plot and data table formats.
- Re-run the analysis at the septum's optimal position.
- Review the E-field results at the septum's optimal position.
- Close the project and exit HFSS software.

View the Cost vs. Solved Iteration

As the solution progresses, view the cost values versus completed iterations in rectangular (X-Y) plot format. The plot indicates how close Optimetrics is to reaching the goal value of 0.

1. Right-click **OptimizationSetup1** in the Project Manager, and then choose **View Analysis Result** from the shortcut menu.

The *Post Analysis Display* dialog box appears.

2. Under the **Result** tab, select **Plot**.

A plot of the cost value at each iteration appears.

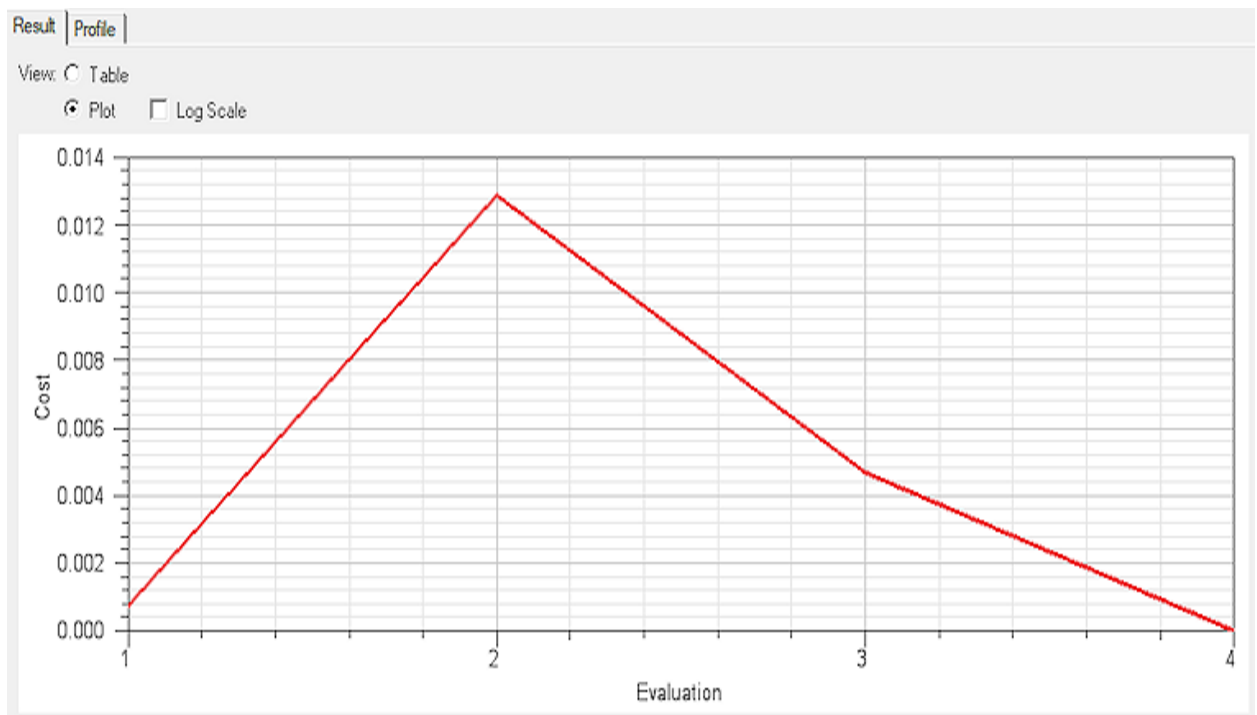

Figure 5-1: Cost vs. Iteration Plot

The optimization stops when it reaches a *Cost* value at or below the acceptable cost you specified (0.001).

3. Select **Table**.

The cost value at each solved design variation is listed in table format.

Evaluation	offset	Cost
1	0.1in	0.00075114
2	0.12in	0.012864
3	0.08in	0.0046833
4	0.092450736in	1.6011e-05

Figure 5-2: Cost vs. Iteration Table

Make a mental note of the optimized Offset value, which should be between 0.09 and 0.1 inch.

4. Click **Close**.
5. From the menu bar, click **HFSS > Design Properties**.

Notice that the value of the *Offset* variable has been updated to the optimization result that satisfied the acceptable cost criterion:

Name	Value	Unit	Evaluated Value	Type
offset	0.092450736293542	in	0.092450736in	Design

Figure 5-3: Updated Offset Value

6. Click **OK** or **Cancel** to close the *Properties* dialog box.

Optional Exercise:

If you would like to compare the optimization behavior just reviewed to that of performing optimization using the previous parametric sweep results, do as follows:

1. Right-click **OptimizationSetup1** in the Project Manager and choose **Delete**.

Note:

Deleting and recreating the optimization setup is necessary to see a change in the optimization iterations. Otherwise the previously run septum offset values will simply be reevaluated. It is not sufficient to clean up the previous results (via **HFSS > Results > Clean Up Solutions**) because the optimization setup will retain the history of prior *Offset* guesses.

2. Return to the [Add an Optimization Setup](#) procedure and identically repeat all of the instructions from there through the *Review the Optimization Results* procedure, **except for the following change**:

When you reach [step 2 of the Solve the Optimization procedure](#), choose **ParametricSetup1** instead of *N/A*. The other settings on the *General* tab can remain at their defaults.

This time, after performing the optimization, the analysis results plot and table should resemble the following two figures:

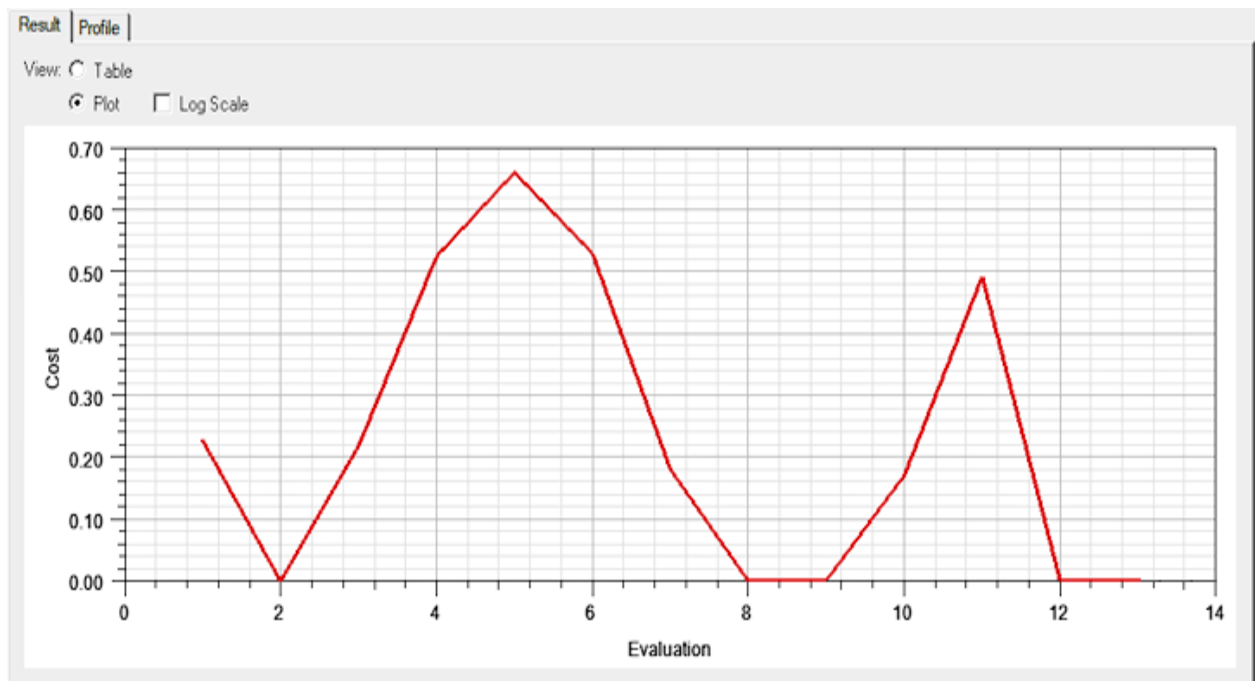
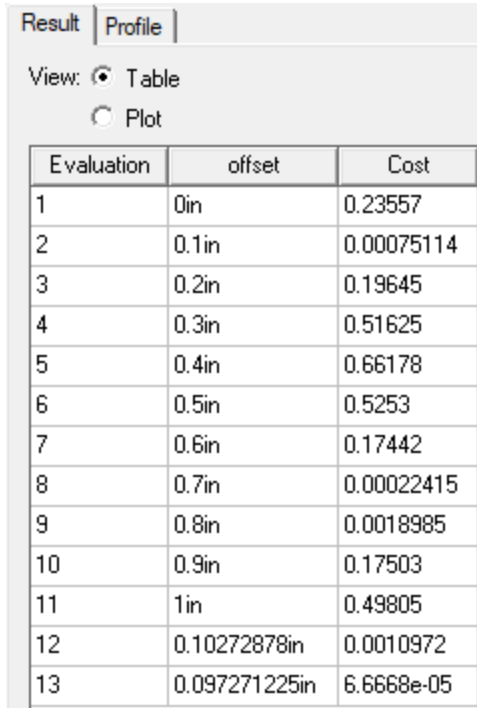

Figure 5-4: Cost vs. Iteration Plot (Using *ParametricSetup1*)



Evaluation	offset	Cost
1	0in	0.23557
2	0.1in	0.00075114
3	0.2in	0.19645
4	0.3in	0.51625
5	0.4in	0.66178
6	0.5in	0.5253
7	0.6in	0.17442
8	0.7in	0.00022415
9	0.8in	0.0018985
10	0.9in	0.17503
11	1in	0.49805
12	0.10272878in	0.0010972
13	0.097271225in	6.6668e-05

Figure 5-5: Cost vs. Iteration Table (Using *ParametricSetup1*)

For the first 11 iterations, Optimetrics referred to the results from the previously run parametric analysis. Optimetrics extracted the cost values from the 11 design variations solved during the parametric analysis and then performed two additional iterations before satisfying the *Cost* criterion.

Reanalyze Design at Optimal Septum Offset

A field solution is unavailable at the optimal value; therefore the field overlay plot *Mag_E1* is considered invalid in its current state. To update the plot, solve the HFSS analysis setup with the *Offset* variable at the optimal value.

Note:

The optimized *Offset* value will be slightly different for those who chose to complete the [Optional Exercise](#) in the preceding topic versus those who chose not to do so. The results presented in this guide are based on the optimization results from the *Optional Exercise* procedure.

1. Under *Analysis* in the Project Manager, right-click **Setup1** and choose **Analyze** from the shortcut menu.

The analysis is expected to take approximately 1 minute to complete.

Update the Field Overlay

1. Double-click the field overlay plot **Mag_E1** to view the updated plot in the view window.

The E-field values indicate that the fields are approximately twice as great moving toward Port3 as they are moving toward Port2.

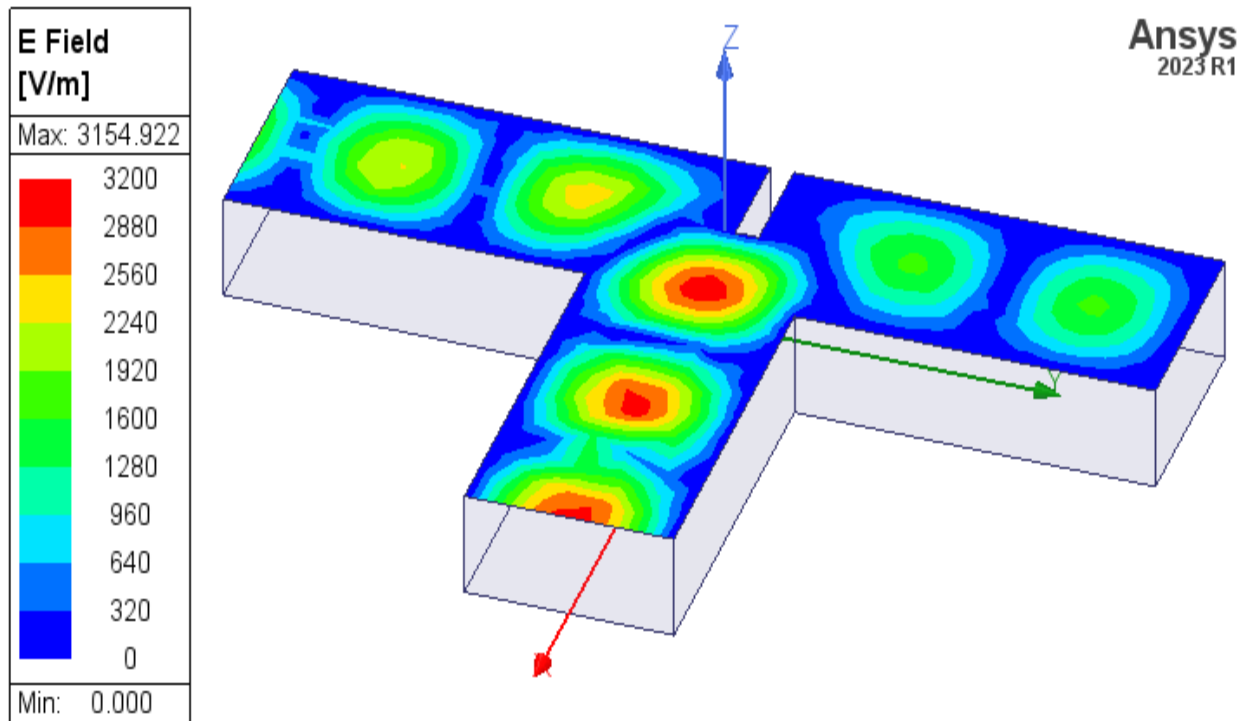



Figure 5-6: *Mag_E1* Field Overlay with Septum at Optimal Position

Close the Project

Congratulations, you have successfully completed this *Tee Waveguide Optimization* exercise!

Before closing the current mode, choose one of the following actions:

- Close the model and make no changes to the current view orientations.
 1.  **Save** your project.
 2. Using the menu bar, click **File > Close**.
- Continue to the [Restore Current View Orientations](#) topic before saving and closing this project.

6 - Optionally, Restore Current View Orientations

You have completed this getting started guide.

If you prefer to use the new view orientations implemented in version 2024 R1 of the Ansys Electronics Desktop application, clear the *Use Legacy View Orientation* option as follows:

1. From the menu bar, click **View > Options**.

The *3D UI Options* dialog box appears.

2. Ensure that **Enable Legacy View Orientation** is cleared:

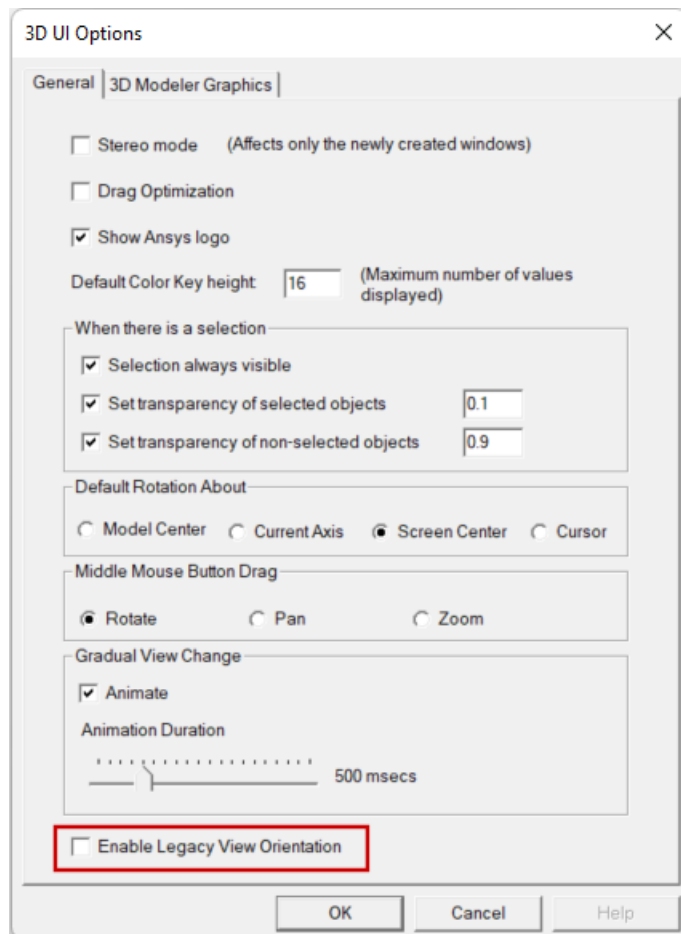

3. Click **OK**.

The settings in the 3D UI Options dialog box are global. Your choice is retained for all future program sessions, projects, and design types that use the 3D Modeler or that produce 3D plots of results.

You can now save and close this project.